

SIEMENS

SITOP PSU2200 3A

6EP3332-3SA00-0AY0

24 V/3 A

中文

ENGLISH

操作说明

Operating Instructions





 The rated temperature of the enclosure of a field-wiring terminal box and the cable is 105°CMin.

 The power supply supplied by 100-240VAC. Please do not touch the section where this label is to avoid the harm during operation.

 Please do not discard.

 Pls must read the instruction manual/booklet before starting work or before operating equipment or machinery.

 Only qualified personnel are allowed to install the device/system and set it into operation.

 Disconnect the machine or equipment before carrying out maintenance or repair.

 Risk of electrical shock.



图 1: 模块图片

Figure 1: View of unit

© Siemens 2022

SITOP PSU2200-01-6C19, 07.2022

简介

SITOP PSU2200 3A 产品属于工业电源, 应用于工业自动化控制领域, 主要给机柜内控制器, 人机界面, 伺服等设备提供 24V 电压。防护等级 IP20, 保护级别为 I 类。

本电源为开关电源. 用于连接到符合 VDE 0100 T 300 / IEC 364-3 的 TN 或 TT 单相交流供电系统, 其额定输入电压为交流 100-240V ac, 50/60 Hz; 额定输出电压为直流 +24V, 电气隔离, 具有短路保护和过压保护功能。

另见图 1

安全提示

注意

本设备/系统的安全正常运行依赖于正确规范的运输、存放、装配、安装作业以及仔细谨慎的操作和维护。

请务必阅读并遵守本设备/系统技术文档中包含的规定和警示, 否则禁止安装和运行本设备。

本设备/系统仅允许由专业技术人员安装和调试。

安装

本设备可安装在符合 EN 60715-TS35-15/7.5 的 DIN 导轨上。

电源是安装在不低于 IP20 的金属工业机柜内的金属导轨上。

安装时应使输入接线端子朝下, 输出接线端子朝上。

确保电源上方和下方至少留有 50mm 之间隔距离, 横向距离至少保持 10mm。

与此设备合并之任何系统的安全乃该系统组装者责任。

户内使用或机柜内使用

接线

警告

在对设备的如何安装或维护作业前, 必须首先断开交流供电系统的主开关, 并采取适宜措施防止交流供电系统再次通电。违反该规定可能会导致作业人员接触到带电零部件, 从而导致严重的人员伤亡。

如果设备未按照制造商指定的方式使用, 设备所提供的保护可能受损。

Description

SITOP PSU2200 3A belongs to industrial power supply, which is applied in industrial automation control. Mainly provides 24V voltage for chassis unit, human-machine interface, servo etc. IP20, safety class I.

Switched-mode power supplies for connection to a 1-phase AC line supply (TN, TT line supply according to VDE 0100 T 300 / IEC 364-3) with rated voltages of 100-240Vac, 50/60Hz; +24VDC Rated output voltage, isolated, short-circuit and overvoltage protection.

See also Figure 1

Safety notes

NOTICE

Appropriate transport, storage, mounting, installation and careful operation maintenance, are essential for device/system safe and reliable operation

All instructions and warnings must be read and obey before setup and operation.

Only qualified personnel are allowed to install or de-bug the device/system.

Assembling

It is installed on standard mounting rails DIN EN 60715-TS35-15/7.5.

The power supply should be mounted on the metal din rail of metal industrial cabinet which is not lower than the IP20.

The device must be installed properly to keep the input terminals at the bottom and the output at the top.

keep a distance of 50mm above and below the device as well as a lateral distance of 10mm to other units.

System installation should take the responsibility of system safety after combination.

Indoor use.

Connecting

WARNING

Before installation or maintenance work can begin, the system's main switch must be switched off and measures taken to prevent it being switched on again. If this instruction is not observed, touching live parts can result in death or serious injury. If the equipment is used in a manner not specified by the manufacturer, the protection provided by the equipment may be impaired.



	①+②
	Phi+Slot NO.1
	1×0.5-6 mm ²
	1×0.5-6 mm ²
AWG	Input:AWG 18-12
	Output:AWG 22-12
Nm	0.5 Nm
	6-7mm

图 2: 接线端子数据
Figure 2: Terminal data



图 3: 结构
Figure 3: Structure

设备安装时需遵循本国相关的作业规范。
输入电压(单相交流 100-240 V ac) 的连接必须按照 IEC 60364 标准的规定。设备适宜安装在优于污染等级 2 级的环境中。

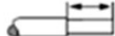
另见图 2

结构

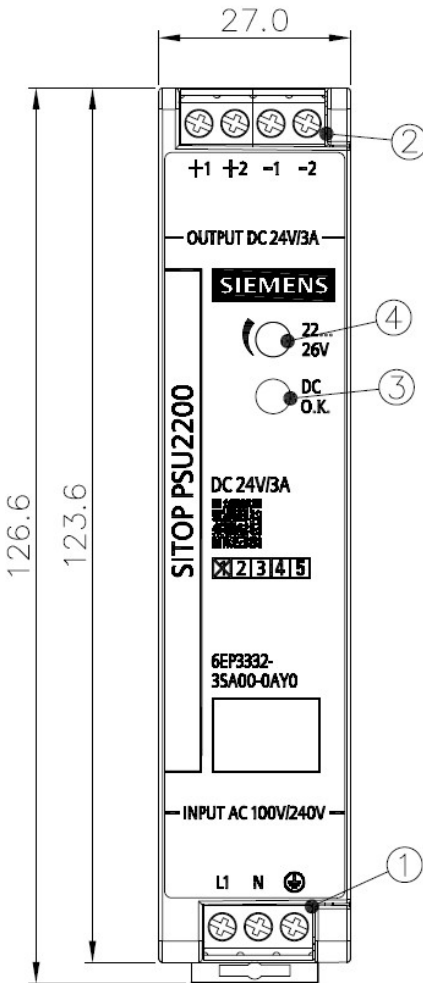
①	交流输入: L、N (Ⓧ PE: 保护地)
②	直流输出: +、-
③	LED 指示灯
④	电位计 (21.6-26V)
⑤	标准导轨附件的环扣, 通过螺丝刀松开
⑥	对流
⑦	上方/下方空间

另见图 3,4

运行模式

信号指示	LED 绿色: 输出电压正常
------	----------------

技术数据

6EP3332-3SA00-0AY0 24V/3A	
输入参数值	
额定输入电压 $U_{in \text{ rated}}$: 单相交流 100-240 V ac, 50/60 Hz	
最大工作电压范围: 单相交流 90-264 V ac	
额定输入电流 $I_{in \text{ rated}}$: 1.80-1.00A	
满载时的输入有功功率 90W	
输出侧参数值	
额定输出电压 $U_{out \text{ rated}} = 24 \text{ V}$	
调节范围: (21.6-26V) 24V 以下限流输出 3.125A 24V 以上限功率输出 (W/V): 75W	
额定输出电流 $I_{out \text{ rated}}$:	
正常情况	3.125 A
容性负载特性: 5000uF Max	
环境条件	
运行温度/湿度: -20... +70 °C; 10-90% -10°C 到 -20°C 时降额系数: 1%/°C 输入 115Vac 温度高于 +40 °C 时降额系数: 1.67%/°C 输入 230Vac 温度高于 +50 °C 时降额系数: 2.5%/°C	
海拔: ≤2000m 满载, 2000m 到 5000m 须降载使用	
防护等级: IP20	
污染等级: 2 级	
过电压类别: II	

For installation of the devices, the relevant country-specific regulations must be observed.

The supply voltage (1-ph. 100-240 V ac) must be connected in accordance with IEC 60364 Installation in environments up to degree of pollution 2.

See also Figure 2

Structure

①	Line input: L、N (Ⓧ PE: Protective Earthing)
②	DC output: +、-
③	LED lamp
④	Potentiometer (21.6-26V)
⑤	Strap of standard DIN rail accessory, which is released by using a screw driver.
⑥	Convection
⑦	Clearance above/below

See also Figure 3,4

Operating mode

Signaling	LED green: Output voltage OK
-----------	------------------------------

Technical data

6EP3332-3SA00-0AY0 24V/3A	
Input variables	
Rated input voltage $U_{in \text{ rated}}$: 1-phase 100-240Vac, 50/60Hz	
Maximum operating voltage range: 1-phase 90-264Vac	
Rated input current $I_{in \text{ rated}}$: 1.80A-1.00A	
Input active power when full load 90W	
Output variables	
Rated output voltage $V_{out \text{ rated}} = 24 \text{ V}$	
Setting range: (21.6-26 V) Below 24V, Current limit: 3.125A Over 24V, Power limit: W/V:75W	
Rated output current $I_{out \text{ rated}}$:	
Normal operation	3.125 A
Capacitive load characteristic: 5000uF Max	
Ambient conditions	
Temperature for operation/ Humidity: -20 to +70 °C; 10-90% -10°C to -20°C de-rate power by 1%/°C Derating: 115Vac Input from +40 °C: 1.67%/°C Derating: 230Vac Input from +50 °C: 2.5%/°C	
Altitude: ≤2000m full load, From 2000m to 5000m for derating use.	
Installation condition of equipment: IP20	
Pollution Degree: Degree 2	
Over voltage Category: II	



图 4: 导轨安装方式和安装空间

Figure 4: Din-rail mounting method

警告: 保护接地线规格不小于 18 AWG, 扭矩 0.5Nm ;

WARNING: The specification of protect ground wire not less than 18 AWG; Torque: 0.5Nm

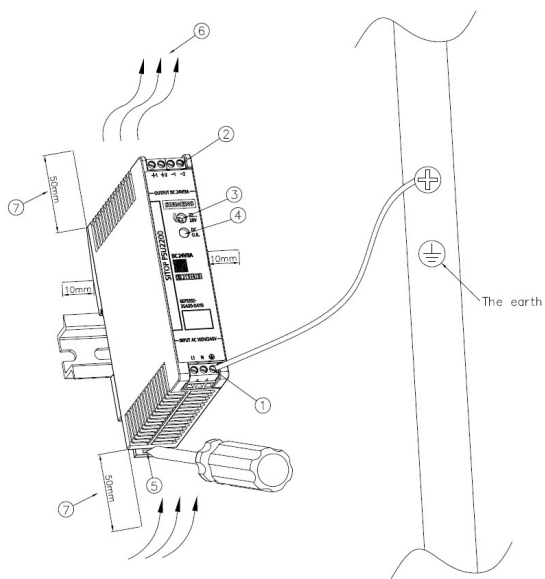
对流: 确保电源上方和下方至少留有 50mm 之间隔距离, 横向距离至少保持 10mm。

存储与运输

温度: -40-85°C

湿度: 5-95%

冲击: 加速 10 g, 测试持续时间 11 毫秒

跌落: 1m(非工作, 带包装)

短路保护功能

电子关闭, 自动重启

净重:

0.22 千克

尺寸: 宽 x 高 x 深 (毫米)

27×123.6×102

Importer UK:

Siemens plc, Manchester M20 2UR

服务与支持

<http://support.automation.siemens.com>

电话: + 49 (0) 911 895 7222

邮箱: service.sitop.cn@siemens.com

Convection: keep a distance of 50mm above and below the device as well as a lateral distance of 10mm to other units.

Transportations &Storage

Temperature: -40-85°C

Relative humidity: 5-95%

Shock: Acceleration 10 g , test duration 11 ms

Drop: 1m(non -working and with package)

Short circuit protection function

Electronic shutdown,automatic restart

Weight

0.22 kg

Dimensions: W × H × D in mm

27×123.6×102

Importer UK:

Siemens plc, Manchester M20 2UR

Service and Support

<http://support.automation.siemens.com>

Telephone: + 49 (0) 911 895 7222

Email:service.sitop.cn@siemens.com